

HPS-600-G Pressure Switch





Technology Ltd

- Pressure switching to very high sensitivity
- Factory set or adjustable actuation setpoint
- Miniature size - ideal for OEM applications
- Wide choice of form factors for maximum installation flexibility
- Long life with high reliability
- UL approved



General Specifications

Actuation pressure / Setpoint tolerance	See detailed information below
Switch type	Single pole, double throw
Contact voltage	125/250 VAC
Current rating	3A, 10A or 15A depending on switch range (Note: Ranges 010, 020 & 902 are 3A, 903 is 10A and 904 & 905 is 15A as standard)
Contact resistance	1Ω max.
Proof pressure	See detailed information below
Material	Thermoplastic case, Urethane diaphragm
Mechanical life	10 x 10 ⁶ cycles
Temperature range	+4°C to +65°C, Some setpoint deviation may occur throughout the temperature range. For increased temperature range of -40 to +96 °C contact us
Approval	UL508 approved. File number NKPZ8.E41523

Model Part Number	Form Factor (see drawings)	Pressure range	Setpoint tolerance	Proof Pressure
HPS-600-G RANGE - 010*		1.25 to 5.0 mbar [0.50" to 2.0" H2O]	± 20%	1.03 bar [15 PSI]
HPS-600-G RANGE - 020*		3.7 to 6.2 mbar [1.5" to 2.5" H2O]	± 20%	1.03 bar [15 PSI]
HPS-600-G RANGE - 902		7.5 to 25 mbar [3" to 10" H2O]	± 20%	1.03 bar [15 PSI]
HPS-600-G RANGE - 903		25 to 69 mbar [10" to 28" H2O]	± 20%	2.07 bar [30 PSI]
HPS-600-G RANGE - 904		69 to 276 mbar [28" to 111" H2O]	± 20%	2.07 bar [30 PSI]
HPS-600-G RANGE - 905		276 to 1036 mbar [111" to 416" H2O]	± 20%	4.83 bar [70 PSI]
HPS-600-G RANGE - 906	Form 1	1036 to 4144 mbar [416" to 1664" H2O]	± 20%	4.83 bar [70 PSI]
HPS-601-G RANGE - 010*		1.25 to 5.0 mbar [0.50" to 2.0" H2O]	± 20%	1.03 bar [15 PSI]
HPS-601-G RANGE - 020*		3.7 to 6.2 mbar [1.5" to 2.5" H2O]	± 20%	1.03 bar [15 PSI]
HPS-601-G RANGE - 902		7.5 to 25 mbar [3" to 10" H2O]	± 20%	1.03 bar [15 PSI]
HPS-601-G RANGE - 903		25 to 69 mbar [10" to 28" H2O]	± 20%	2.07 bar [30 PSI]
HPS-601-G RANGE - 904		69 to 276 mbar [28" to 111" H2O]	± 20%	2.07 bar [30 PSI]
HPS-601-G RANGE - 905		276 to 1036 mbar [111" to 416" H2O]	± 20%	4.83 bar [70 PSI]
HPS-601-G RANGE - 906	Form 2	1036 to 4144 mbar [416" to 1664" H2O]	± 20%	4.83 bar [70 PSI]
HPS-602-G RANGE - 010*		1.25 to 5.0 mbar [0.50" to 2.0" H2O]	± 20%	1.03 bar [15 PSI]
HPS-602-G RANGE - 020*		3.7 to 6.2 mbar [1.5" to 2.5" H2O]	± 20%	1.03 bar [15 PSI]
HPS-602-G RANGE - 902		7.5 to 25 mbar [3" to 10" H2O]	± 20%	1.03 bar [15 PSI]
HPS-602-G RANGE - 903		25 to 69 mbar [10" to 28" H2O]	± 20%	2.07 bar [30 PSI]
HPS-602-G RANGE - 904		69 to 276 mbar [28" to 111" H2O]	± 20%	2.07 bar [30 PSI]
HPS-602-G RANGE - 905		276 to 1036 mbar [111" to 416" H2O]	± 20%	4.83 bar [70 PSI]
HPS-602-G RANGE - 906	Form 3	1036 to 4144 mbar [416" to 1664" H2O]	± 20%	4.83 bar [70 PSI]

Note: * = Non adjustable



HPS-600-G Pressure Switch

Reference Dimensions (mm)

Form 1 - non adjustable
HPS-600 - G

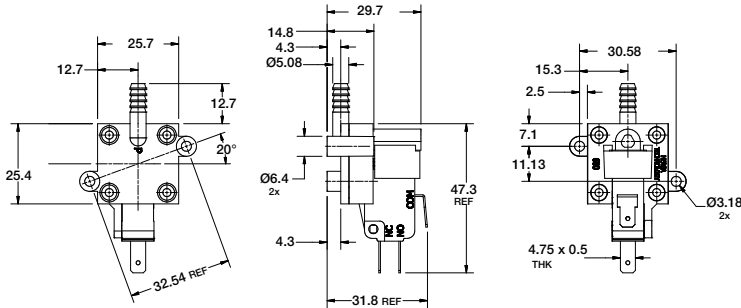

Form 1 - adjustable
HPS-600 - G

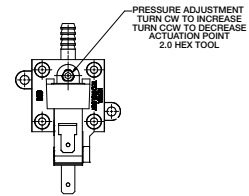

Form 2 - non adjustable
HPS-601 - G

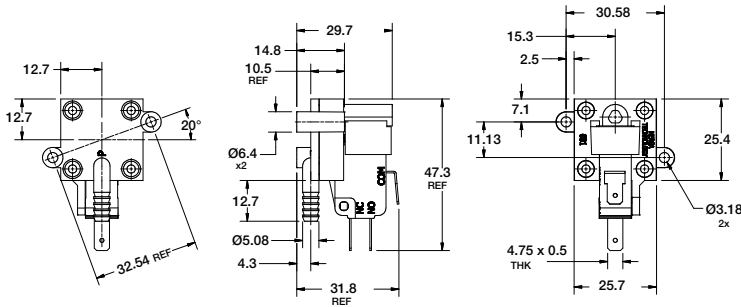

Form 2 - adjustable
HPS-601 - G

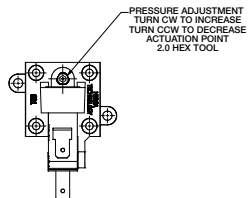

Form 3 - non adjustable
HPS-602 - G

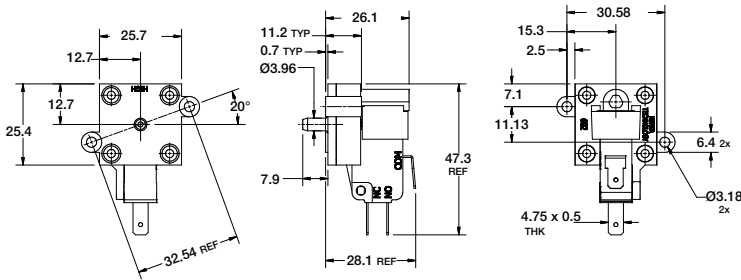

Form 3 - adjustable
HPS-602 - G

